

# The Classic Collection



Cast-iron fireplace packages for your home

## Contents

Clifton Arch	3
Royal Arch	4
Royal Arch HP	5
Newcastle	6
Tulip Arch	7
Washington	8
Lonsdale	9
Malvern	10
Art Nouveau	11
Glen	12
Balmoral	13
Vienna	14
Kendal	15
Granite Set	16
Recessed Tile Set	17
Tiles	18
Technical Information	19

## Cast-iron Care

Your Classic cast-iron fireplace should be stored in a warm, dry environment and remain packaged until the fireplace is ready to be installed. This will prevent accidental damage being caused, which will not be covered under warranty.

Your Classic casting requires only the minimum upkeep and it should remain in superb condition for many years. Matt black, graphite & polished finishes can be maintained simply by dusting with a dedicated dry paint brush.

It is normal for some discoloration to occur to the working parts of a cast-iron fireplace. If discolouration is likely to cause some distress, especially if solid fuel is being used, use a black or graphite finish and remember that cast-iron is robust and can always be refurbished when not in use.

Graphite is liable to leave marks on fingers etc. where contact is made and will need to be cleaned off.

Cast-iron products are vulnerable to rust and tarnishing if exposed to dampness or water. Avoid contact with damp cloths, wet plaster, wallpaper steamers, water-based liquids, furniture polish, etc. to the surface of the cast-iron. Should your fireplace become wet for any reason, dab it gently with a simple dry cloth. This should prevent any tarnishing or rust from forming.

See **Accessories** p18 for products available.

The Classic Collection is a range of traditional fireplace packages consisting of a cast-iron insert, an elegant mantel in solid pine or solid oak, a choice of granite or tiled hearth and the option of decorative tubeline tiles if desired.

Combine these products together as displayed in your Classic Collection brochure or mix and match them to form your own bespoke fireplace suitable for gas, electric or solid fuel.

Distributed throughout the UK by a professional group of companies, the Classic Collection can be purchased via a network of local independent retailers who employ experienced, knowledgeable staff and have the capability to arrange an installation with a suitably qualified heating engineer.

## Finishes

Classic cast-iron fireplaces are available in three separate finishes, Matt Black, Antique (graphite) or Highlight Polished as shown below.



Matt Black



Antique



Highlight Polished

### Front cover image:

<b>Cast</b>	Clifton Arch Black
<b>Mantel</b>	Grizedale Pine ( <i>available in Oak</i> )
<b>Fire-Back</b>	Attached
<b>Hearth</b>	Tiled (Ciara Slate) 1315mm x 437mm x 65mm
<b>Gas</b>	✓ Cast Tec Arch
<b>Solid Fuel</b>	✓ SF Kit C
<b>Electric</b>	✓ Electric Arch

# Clifton Arch



The Clifton Arch is a traditional arched insert with an attractive decorative arched design shown here in a highlight polished finish. The same casting is shown on the front cover of this brochure in a matt black finish. The mantel shown is the Sherwood in Solid Oak (Pine option is shown on page 13).

<b>Cast</b>	Clifton Arch Polished
<b>Mantel</b>	Sherwood Oak ( <i>available in Pine</i> )
<b>Fire-Back</b>	Attached
<b>Hearth</b>	Granite 1372mm x 381mm (54" x 15")

<b>Gas</b>	✓	Cast Tec Arch
<b>Solid Fuel</b>	✓	SF Kit C
<b>Electric</b>	✓	Electric Arch



# Royal Arch



The Royal Arch is an elegant contemporary arched insert available in matt black or with a simple polished arched band as shown. The mantel shown is the Incised Corbel in Solid Pine.

<b>Gas</b>	✓	Cast Tech Arch
<b>Solid Fuel</b>	✓	SF Kit C
<b>Electric</b>	✓	Electric Arch

<b>Cast</b>	Royal Arch
<b>Mantel</b>	Incised Corbel Pine ( <i>available in Oak</i> )
<b>Fire-Back</b>	Attached
<b>Hearth</b>	Granite 1372mm x 381mm (54" x 15")

# Royal Arch HP



The Royal Arch Half Polish is a contemporary arched insert with a substantial polished area between the arched band and the fireplace opening giving a more bold appearance. The mantel shown is the Georgian in Solid Pine.

<b>Cast</b>	Royal Arch Half Polish
<b>Mantel</b>	Georgian Pine ( <i>available in Oak</i> )
<b>Fire-Back</b>	Attached
<b>Hearth</b>	Granite 1372mm x 381mm (54" x 15")

<b>Gas</b>	✓	Cast Tec Arch
<b>Solid Fuel</b>	✓	SF Kit C
<b>Electric</b>	✓	Electric Arch



# Newcastle



The Newcastle is a plain arched insert available in a matt black or polished finish (as shown). Together with the Rothbury mantel in Solid Oak this package has a rather contemporary and minimalist feel (The Rothbury is also shown on page 10 in Pine).

<b>Gas</b>	✓	Cast Tec 16
<b>Solid Fuel</b>	✓	SF Kit T
<b>Electric</b>	✓	Electric 16

<b>Cast</b>	Newcastle
<b>Mantel</b>	Rothbury Oak ( <i>available in Pine</i> )
<b>Fire-Back</b>	Optional
<b>Hearth</b>	Granite 1220mm x 381mm (48" x 15")

# Tulip Arch



The Tulip Arch is shown in a highlight polished finish and sports a decorative arched band and a distinctive tulip motif on the canopy. The Tulip mantel is available in Solid Pine (as shown) or Solid Oak and portrays beautiful hand carved tulip flowers with long stems on either side.

<b>Cast</b>	Tulip Arch
<b>Mantel</b>	Tulip Pine ( <i>available in Oak</i> )
<b>Fire-Back</b>	Optional
<b>Hearth</b>	Granite 1220mm x 381mm (48" x 15")

<b>Gas</b>	✓	Cast Tec 16
<b>Solid Fuel</b>	✓	SF Kit T
<b>Electric</b>	✓	Electric 16



# Washington



The Washington has a simple square design and is shown here in a matt black finish but is also available highlight polished (see inset). The mantel shown is the Flat Victorian in Solid Oak (also shown on page 11 in Solid Pine).

<b>Gas</b>	✓	Cast Tec 16
<b>Solid Fuel</b>	✓	SF Kit U
<b>Electric</b>	✓	Electric 16
<b>Integra</b>	✓	High Efficiency Option

<b>Cast</b>	Washington
<b>Mantel</b>	Flat Victorian Oak ( <i>available in Pine</i> )
<b>Fire-Back</b>	Optional
<b>Hearth</b>	Granite 1372mm x 381mm (54" x 15")





The Lonsdale is a decorative arched insert with an attractive canopy shown here in a highlight polish finish. The mantel shown is the Balmoral in Solid Pine.

<b>Cast</b>	Lonsdale
<b>Mantel</b>	Balmoral Pine ( <i>available in Oak</i> )
<b>Fire-Back</b>	Optional
<b>Hearth</b>	Granite 1372mm x 381mm (54" x 15")

<b>Gas</b>	✓	Cast Tec 16
<b>Solid Fuel</b>	✓	SF Kit U
<b>Electric</b>	✓	Electric 16

# Malvern



The Malvern is an elegant insert with intricate detail shown here in a highlight polish finish. The mantel shown is the Rothbury in Solid Pine (also shown on page 6 in Solid Oak).

<b>Gas</b>	✓	Cast Tec 16
<b>Solid Fuel</b>	✓	SF Kit U
<b>Electric</b>	✓	Electric 16
<b>Integra</b>	✓	High Efficiency Option

<b>Cast</b>	Malvern
<b>Mantel</b>	Rothbury Pine ( <i>available in Oak</i> )
<b>Fire-Back</b>	Optional
<b>Hearth</b>	Granite 1220mm x 381mm (48" x 15")



# Art Nouveau



The Art Nouveau is a decorative Edwardian tiled insert available in a matt black or polished finish. The mantel shown is the Flat Victorian in Solid Pine (also shown on page 8 in Solid Oak).

<b>Cast</b>	Art Nouveau
<b>Mantel</b>	Flat Victorian Pine ( <i>available in Oak</i> )
<b>Fire-Back</b>	Optional
<b>Hearth</b>	Granite 1372mm x 381mm (54" x 15")
<b>Tiles</b>	Mediterranean Poppy Honey/Yellow

<b>Gas</b>	✓	Cast Tec 16
<b>Solid Fuel</b>	✓	SF Kit U
<b>Electric</b>	✓	Electric 16

# Glen



The Glen is an Adam-style tiled insert with a decorative band and canopy shown here in a highlight polished finish. The Corbel mantel is available in Solid Pine (as shown) or Solid Oak.

<b>Gas</b>	✓	Cat Tec 16
<b>Solid Fuel</b>	✓	SF Kit G
<b>Electric</b>	✓	Electric 16

<b>Cast</b>	Glen
<b>Mantel</b>	Corbel Pine ( <i>available in Oak</i> )
<b>Fire-Back</b>	Optional
<b>Hearth</b>	Granite 1372mm x 381mm (54" x 15")
<b>Tiles</b>	Oriental Iris Ivory/Blue





The Balmoral is a decorative traditional tiled insert shown here in a highlight polished finish. Also available in matt black the Balmoral is shown inside the Sherwood mantel in Solid Pine (also shown on page 3 in Solid Oak).

<b>Cast</b>	Balmoral
<b>Mantel</b>	Sherwood Pine ( <i>available in Oak</i> )
<b>Fire-Back</b>	Optional
<b>Hearth</b>	Granite 1372mm x 381mm (54" x 15")
<b>Tiles</b>	Oriental Iris Ivory/Burgundy

<b>Gas</b>	✓	Cast Tec 16
<b>Solid Fuel</b>	✓	SF Kit G
<b>Electric</b>	✓	Electric 16

# Vienna



The Vienna is a combination of a tiled insert with a mantleshaft attached. The Art Nouveau styling depicted on the casting is shown here in a highlight polished finish.

<b>Gas</b>	✓	Cast Tec 16
<b>Solid Fuel</b>	✓	SF Kit G
<b>Electric</b>	✓	Electric 16

<b>Cast</b>	Vienna
<b>Fire-Back</b>	Optional
<b>Hearth</b>	Granite 1067mm x 381mm (42" x 15")
<b>Tiles</b>	Mediterranean Poppy Ivory/Burgundy





The Kendal is an attractive cast fascia with a standard fireplace opening allowing it to be used with a wide range of gas, electric or solid fuel insets. Available polished or matt black the Kendal is shown inside the Grizedale mantel in Solid Pine (also shown on page 16 in Solid Oak).

The Classic Multiflue gas fire is shown with a chrome trim and polished Bauhaus fret. See other options available on pages 16/17.

<b>Cast</b>	Kendal
<b>Mantel</b>	Grizedale Pine (available in Oak)
<b>Hearth</b>	Tiled (Ciara Slate) 1315mm x 437mm x 65mm

<b>Gas</b>	✓	Classic Multiflue
<b>Solid Fuel</b>	✓	Options Available
<b>Electric</b>	✓	Options Available
<b>Integra</b>	✓	High Efficiency Option

# Granite Set



## Classic Multiflue

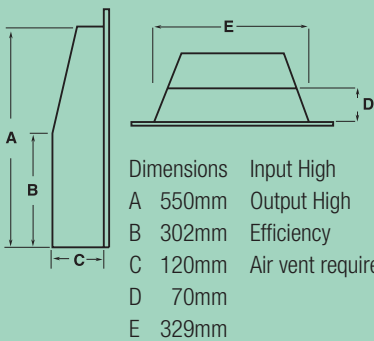

<b>Gas</b>	✓	Classic Multiflue
<b>Integra</b>	✓	High Efficiency Option

The simplicity of a Black Granite Hearth and Back Panel is guaranteed to compliment your décor and show the mantel, in this case the Grizedale in Solid Oak, off to its' full extent. The Grizedale is also shown on the front cover in Solid Pine.

The Classic Multiflue gas fire is shown with a chrome trim and Media fret and is shown on page 17 with a black trim and Bauhaus fret.

<b>Mantel</b>	Grizedale Oak ( <i>available in Pine</i> )
<b>Back Panel</b>	Granite 940mm x 940mm
<b>Hearth</b>	Granite 1372mm x 381mm (54" x 15")



# Recessed Tile Set



The Ciara Slate matt black porcelain tile set is shown here with a recessed back panel which is ideal to house a gas, electric or solid fuel appliance. The back panel, which can also be flat, is also available in a light brown Sienna Earth tile (see Back Cover). The mantel shown is the Danbury available in Solid Pine (as shown) or Solid Oak.

<b>Mantel</b>	Danbury Pine ( <i>available in Oak</i> )
<b>Back Panel</b>	Tiled (Ciara Slate) 940mm x 940mm
<b>Hearth</b>	Tiled (Ciara Slate) 1315mm x 437mm x 65mm

<b>Gas</b>	✓	Classic Multiflue
<b>Solid Fuel</b>	✓	Options Available
<b>Electric</b>	✓	Options Available
<b>Integra</b>	✓	High Efficiency Option

# Hand Painted Tubeline Tiles

Our tubeline tiles are individually handpainted in the traditional way and will be subject to colour variation and normal crazing. Cast-iron sleeves are an alternative to the more colourful tubeline tiles.

Two sleeves or tile-runs, some of which have a left and right handed design, make up a set to suit a Classic casting. Cast-iron sleeves are available in matt black, antique or highlight polished finishes.

## Liberty



Brown Yellow Ivory Blue Green Burgundy Honey Yellow Ivory Burgundy

## Oriental Iris

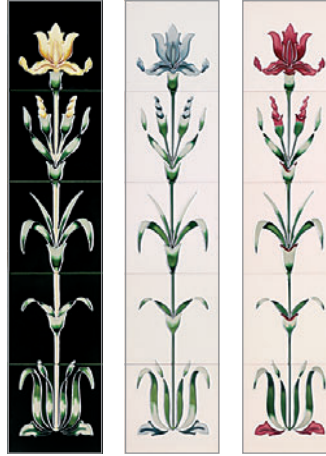

Green Yellow Ivory Blue Ivory Burgundy

## Luscia



Honey Yellow Ivory Blue Ivory Burgundy

## Mediterranean Poppy



Honey Yellow Ivory Burgundy Green Burgundy Ivory Blue

## Tulip

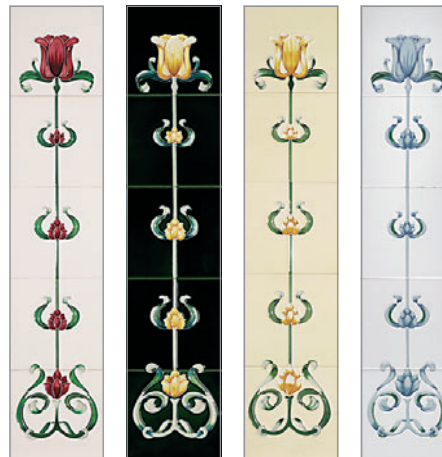

Ivory Burgundy Green Yellow Honey Yellow Ivory Blue

## Cast-Iron Sleeves



Lily Urn Med Poppy Tulip

# Electric Options

There are two electric fires manufactured specifically to suit the majority of castings in the Classic Collection.

The Cast Tec **Electric 16** (supplied with Damper for use with Universal Cast Back) & Cast Tec **Electric Arch** offer the following unique points:

- **Top Venting** (so that Ashpan Cover can stay in position)
- **Two Heat Settings** (900W & 1800W)
- **Remote Control** (multiple flame settings)
- **LED Effect** (No bulbs to change)
- **Adjustable Height**



# Accessories

Firemaster Stove Paint (matt black finishes), Grate Polish (antique finishes) and Metal Polish (polished finishes) can be applied to your cast-iron fireplace but only in exceptional circumstances with expert advice and taking the utmost care.





# Technical Information

Castings*	Fascia Sizes		Inner Band Sizes		E Rebate	Chamber Sizes		
	A Width	B Height	C Width	D Height		F Width	G Height	H Depth
Art Nouveau	956	959	864	870	76	See Optional Backs		
Balmoral	955	960	870	870	76	See Optional Backs		
Clifton	950	950	770	825	10	660	790	190
Glen	955	960	865	865	76	See Optional Backs		
Kendal	945	950	770	837	76	See Optional Backs		
Lonsdale	955	950	760	830	76	See Optional Backs		
Malvern	934	934	725	816	76	See Optional Backs		
Newcastle	950	950	780	840	76	See Optional Backs		
Royal	950	950	790	835	10	660	790	190
Tulip	950	950	780	840	76	See Optional Backs		
Vienna	1045	1145	920	n/a	Flush	See Optional Backs		
Washington	1010	970	806	867	76	See Optional Backs		

maximum mantel openings      minimum mantel openings

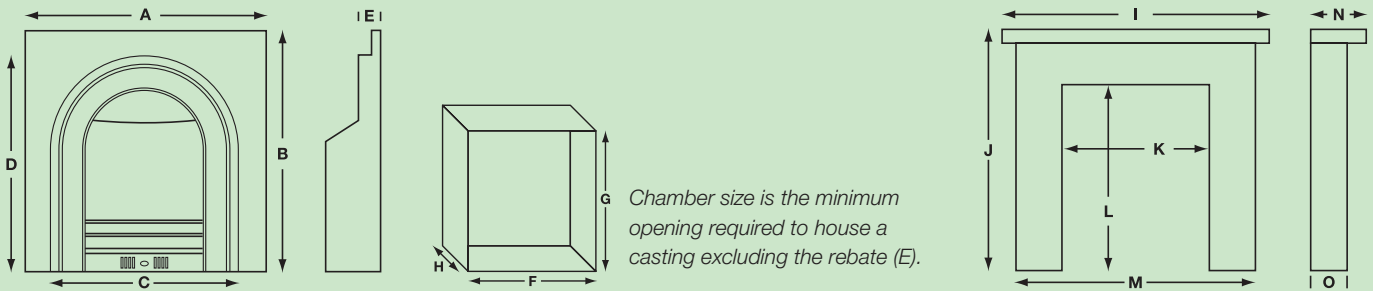

Mantels	I Shelf Length	J Height	K Internal Width	L Internal Height	M Base	N Shelf Width	O Rebate
Balmoral	1372	1134	915	915	1235	213	25/76
Corbel	1400	1155	915	915	1330	213	25/76
Danbury	1372	1225	915	915	1200	200	25/76
Flat Victorian	1448	1150	915	915	1327	200	25/76
Georgian	1400	1115	915	915	1225	200	25/76
Grizedale	1370	1135	900	900	1215	195	25/76
Incised Corbel	1400	1155	915	915	1330	213	25/76
Sherwood	1372	1175	915	915	1283	219	25/76
Rothbury	1330	1134	900	915	1205	213	25/76
Tulip	1305	1137	900	915	1205	203	25/76



Universal Cast Back      Fibre Back      Milner Fire Clay

Optional Backs	F Width	G Height	H Depth
Universal Cast Back <i>suits gas, electric and solid fuel</i>	432	623	191
Fibre Back <i>gas only, increases output 1kW</i>	445	585	204
Milner Fire Clay <i>solid fuel</i>	508	585	229

\*Due to the casting process measurements are approximate and may vary.

# Tiled Hearths

Our Porcelain tiled hearths are available in a matt black Ciara Slate finish and a light brown Sienna Earth finish (each tile is 148mm square).

All hearths are slabbed and reinforced enabling them to be used with solid fuel appliances.

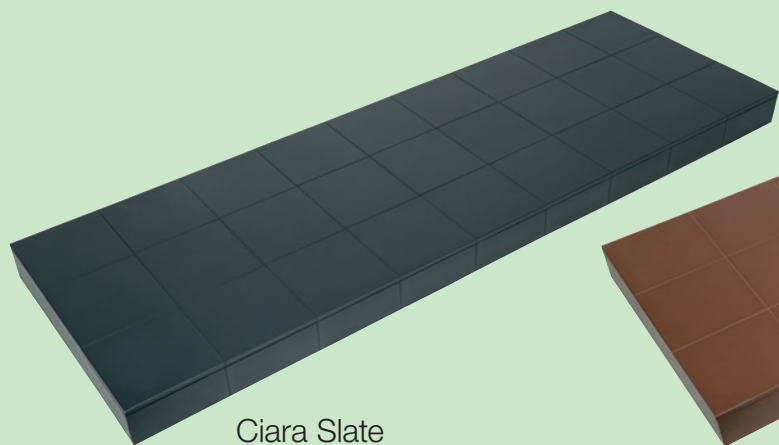

Ciara Slate

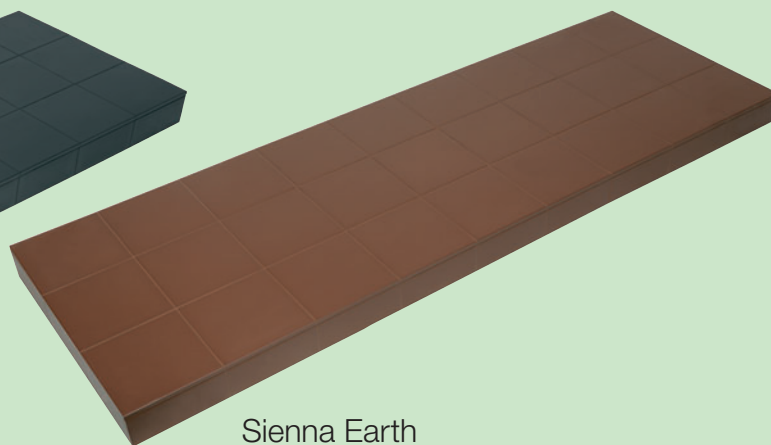

Sienna Earth

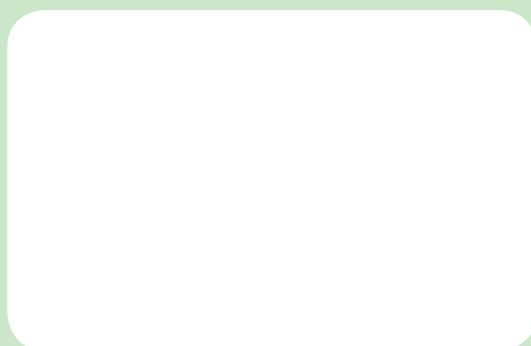

Dealer Stamp

## IMPORTANT INFORMATION

Products shown in this brochure are manufactured for Cast Tec Ltd. who, with a professional group of companies, distribute them exclusively in the UK.

Goods must be checked prior to installation, as no responsibility will be accepted thereafter for the redecoration, removal or reinstallation of products. Faulted goods must be reported within 48 hours.

Installation should be carried out by a qualified professional fireplace fitter. No responsibility will be accepted for damage or problems arising from an incorrect or unqualified installation.

When burning solid fuel, a new cast-iron fireplace must be tempered by burning five small fires of no more than 3kg of fuel. This procedure will ensure that heat damage through consistent use of the product will be minimised. Caution must be taken

with petroleum based solid fuels as the heat intensity can cause damage to consumable products such as the fire-brick, bottom grate and ashpan.

Cast Tec Arches & 16s are CE approved and manufactured specifically to suit the Classic Collection range of castings. No responsibility will be accepted for problems arising where a gas appliance has been used which is not approved or suitable to fit into a Classic casting or where the fitting has taken place without the relevant instructions.

Cast Tec Ltd. reserve the right to delay or withdraw products, change designs, specifications or materials without prior notice due to continuous product development or supply problems.

Photographs and designs shown in this brochure are the copyright and design rights of Cast Tec Ltd. and can only be used or copied with permission.